

# Data Sheet



Article number: 204050M1060A0S

Description: E+G levelling foot  
GN 40-50-M10-60-A0-S

Note: S Without nut, External hexagon at the bottom

## Measures

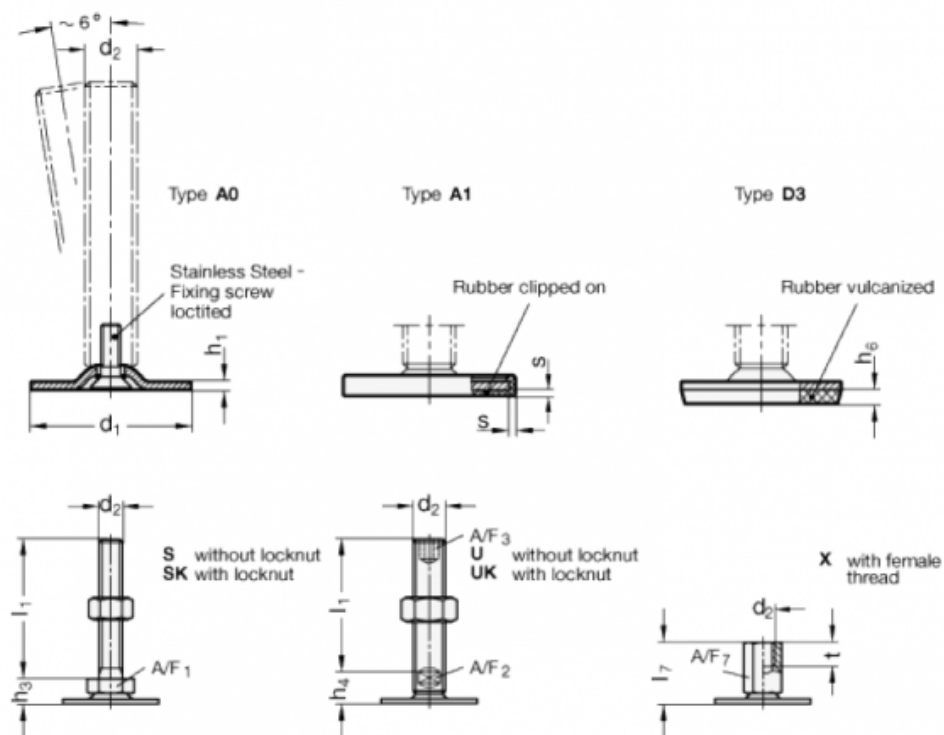

A/F1	= 17
d1	= 50
d2	= M10
h1	= 2.5
h3	= 11
h6	=
l1	= 60
s	=